

Article number: 3213315

Description: Ortlinghaus Coupling size 15

Measures

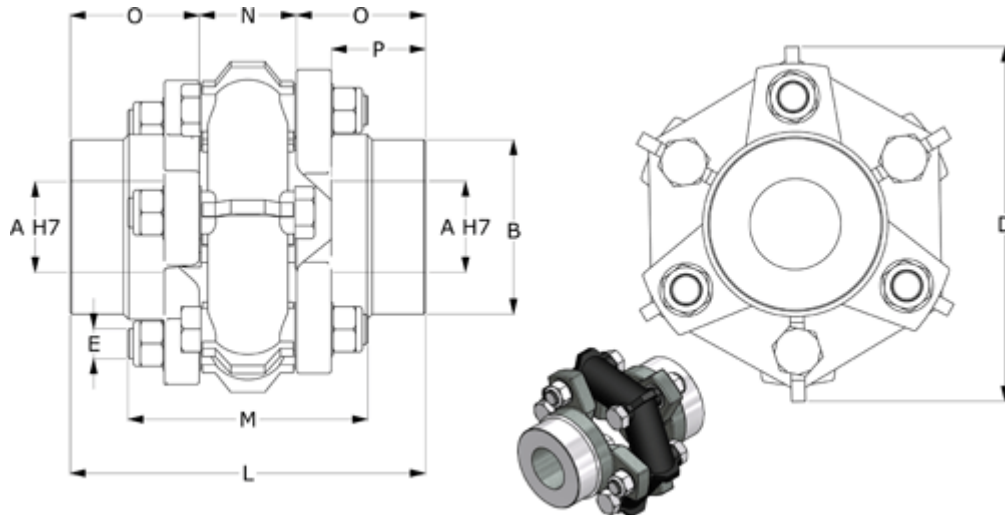

A max H7	= 30	M	= 72	Tightening torque N m	= 25
Axial displacement mm	= +/-3	Moment of inertia kg/m ²	= 0.00038	Weight	= 1.0
B	= 45	N	= 28		
Bending angle	= +/-2,8	O	= 36		
C	= 65	P	= 30		
D	= 93	Radial displacement	= +/-0,5		
E	= M6	Standard running NM	= 40		
L	= 100	Stress load Nm	= 100		